



NMT PLUS 20/80-130

979523847

NMT PLUS / Electronically regulated circulating pump
 Heating/cooling, Klimatizacija

GENERAL

Part number	979523847		
Part name	NMT PLUS 20/80-130		
Seal type		EEl	0.2
Net weight	2.20 [kg]		
H max	7.66 [m]	H min	0.0 [m]
Q max	3.46 [m3/h]	Q min	0.0 [m3/h]
	36 [%]		
Noise	≤43 dB(A)		

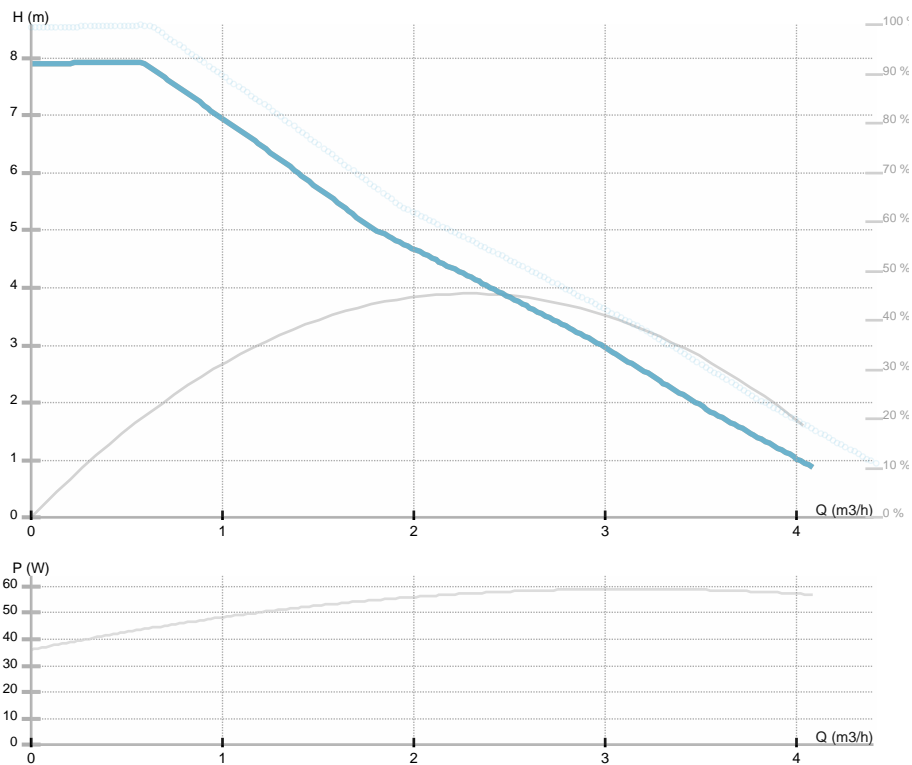

ELECTRICAL DATA

Power supply	1~230 V
Mains frequency	50 Hz
Motor power	57 [w]
RPM	4800 [1/min]
Insulation class	F
Declared current	0.5 [A]
Declared protection	IP44
Thermal protection	
Frame size	
Motor IE class	

INSTALLATION

Fluid	Water VDI 2035, glycol 40%
Fluid temperature	-10.0 ÷ 110.0 [°C]
Ambient temp.range	40 deg C
Length	130 [mm]
DN	20 [mm]
Connector	G 1 ¼
Connection	G 1 ¼
Max pressure	1.0 MPa

MATERIAL

Bearing material	Ceramics
Impeller material	Noryl 1630V
Hydraulics material	Gray cast iron
Shaft material	Ceramics

NMT PLUS 20/80-130

979523847

NMT PLUS / Electronically regulated circulating pump

Heating/cooling, Klimatizacija





NMT PLUS 20/80-130

979523847

NMT PLUS / Electronically regulated circulating pump
Heating/cooling, Klimatizacija

Dimension drawing

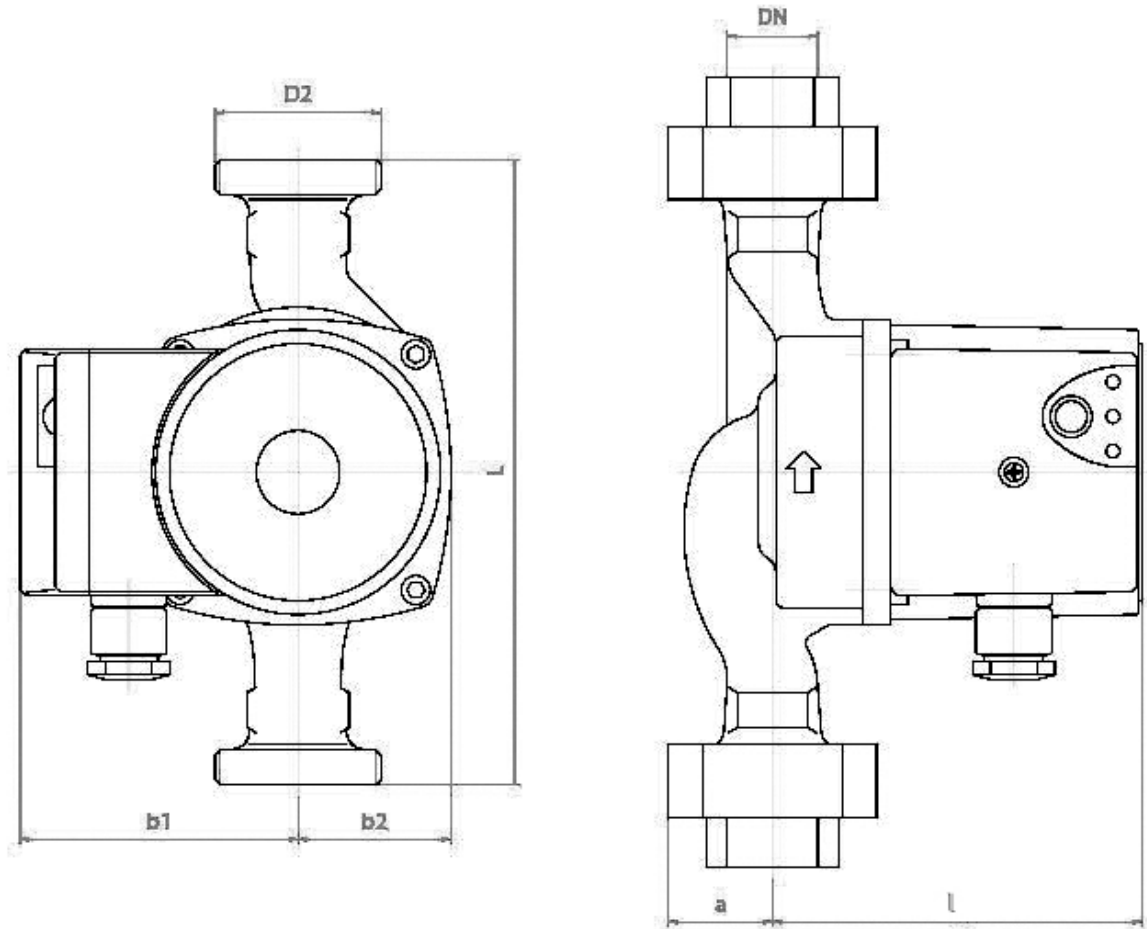

L=130 DN=20 b1=79 b2=47,5 l=108 a=29 D2=5/4



NMT PLUS 20/80-130

979523847

NMT PLUS / Electronically regulated circulating pump
Heating/cooling, Klimatizacija

Electrical wiring

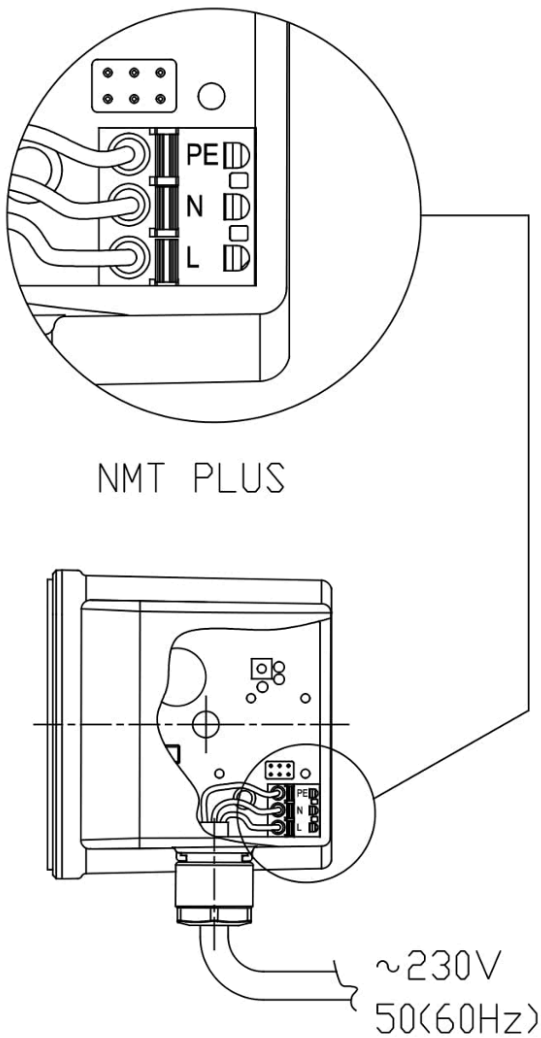

NMT PLUS



NMT PLUS 20/80-130

979523847

NMT PLUS / Electronically regulated circulating pump
Heating/cooling, Klimatizacija