

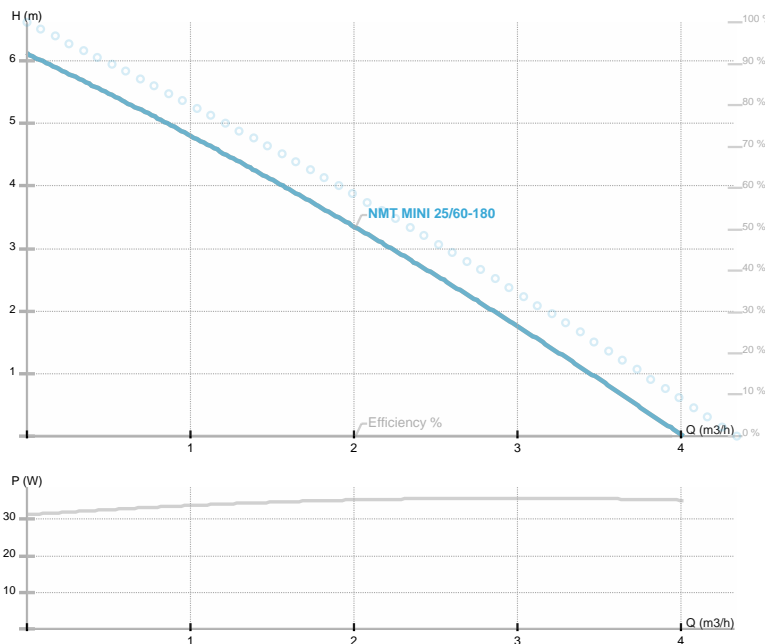

NMT MINI 25/60-180

NMT MINI



Part number	979525371
Power supply	1~230 V
Declared protection	IP44
Q max	4.0 [m³/h]
H max	6.1 [m]
RPM	4900 [1/min]
Motor power	35 [w]
Declared current	0.32 [A]
Fluid	Water VDI 2035, glycol 40%
Fluid temperature	-10.0 ÷ 110.0 [°C]
Insulation class	F
DN	25 [mm]
Connector	Rp 1
Net weight	1.73 [kg]
Length	180 [mm]
Approvals	
EEL	0.16
Efficiency	[%]
Impeller material	Noryl Fe 1630PW
Bearing material	all carbon
Shaft material	AISI 420
Hydraulics material	Gray cast iron
Mains frequency	50/60 Hz
Connection	Rp 1
Max pressure	1.0 MPa
Ambient temp.range	40 deg C

Drawing

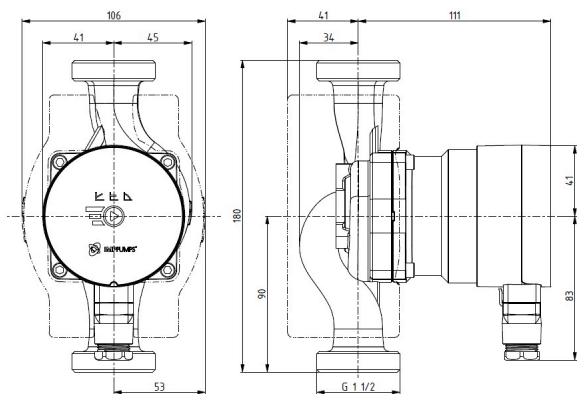

Electrical wiring

